

Overview



Introduction

The P4S-347-R2 (PHPoC Wi-Fi Shield 2 for Arduino) is a shield that connects Arduino to a wireless network. After attaching this shield on top of the Arduino and connecting the USB wireless dongle, you can connect Arduino to the Internet by simply setting up the network.

The network function of this shield is based on the TCP/IP stack using PHPoC interpreter. The shield can be easily accessed by PHPoC Library. PHPoC Library is very similar to the usage of Arduino Ethernet library. Therefore, source codes using existing Ethernet library can be used immediately after modifying just few lines. Furthermore, Phpoc Library has a wider range of applications since it supports a variety of API(TELNET, Web socket and ESMTP).

Unlike the [existing PHPoC Wi-Fi Shield \(P4S-347\)](#), the P4S-347-R2 is equipped with an SPC port for communication with the Smart Expansion Boards for Shield 2, which provides a wide range of applications.

※ [What is smart expansion boards for Shield 2?](#)

Features

- Equipped with SPC port: for smart expansion boards for Shield 2
- Wi-Fi Shield for Arduino (Compatible boards: Uno and Mega)
- Communication with Arduino by SPI
- Power: DC 5V (Supplied from Arduino boards)
- Network controller: PHPoC interpreter
- Wireless LAN: IEEE802.11b/g
- WLAN security: WPA-PSK/Enterprise
- Web settings (Smartphone or PC)
- Embedded web applications: Web Serial monitor, Web Serial Plotter, Web Remote control (Push, Slide and Pad)
- Save time information (RTC - Battery Backup)

- Support IPv6

Protocol Stack

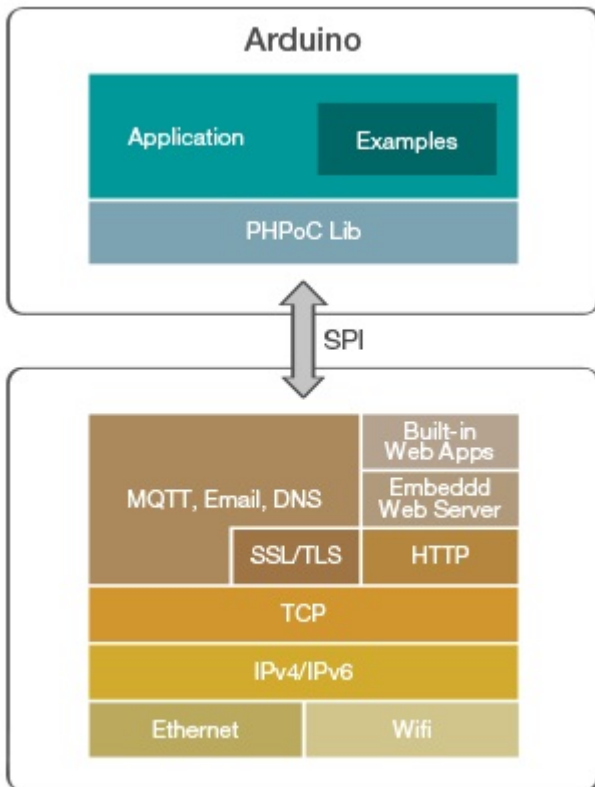

Hardware Specifications

Block Diagram

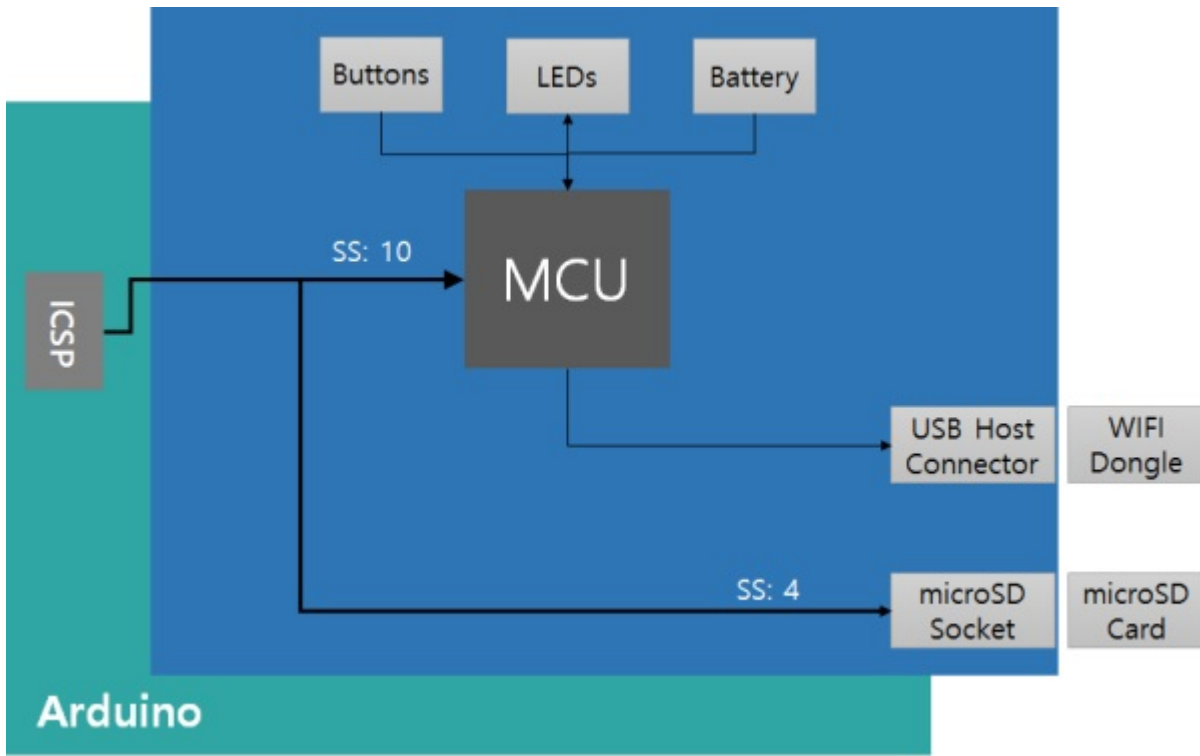

Dimension

The dimensions of P4S-347-R2 are as follows: (Unit: mm)

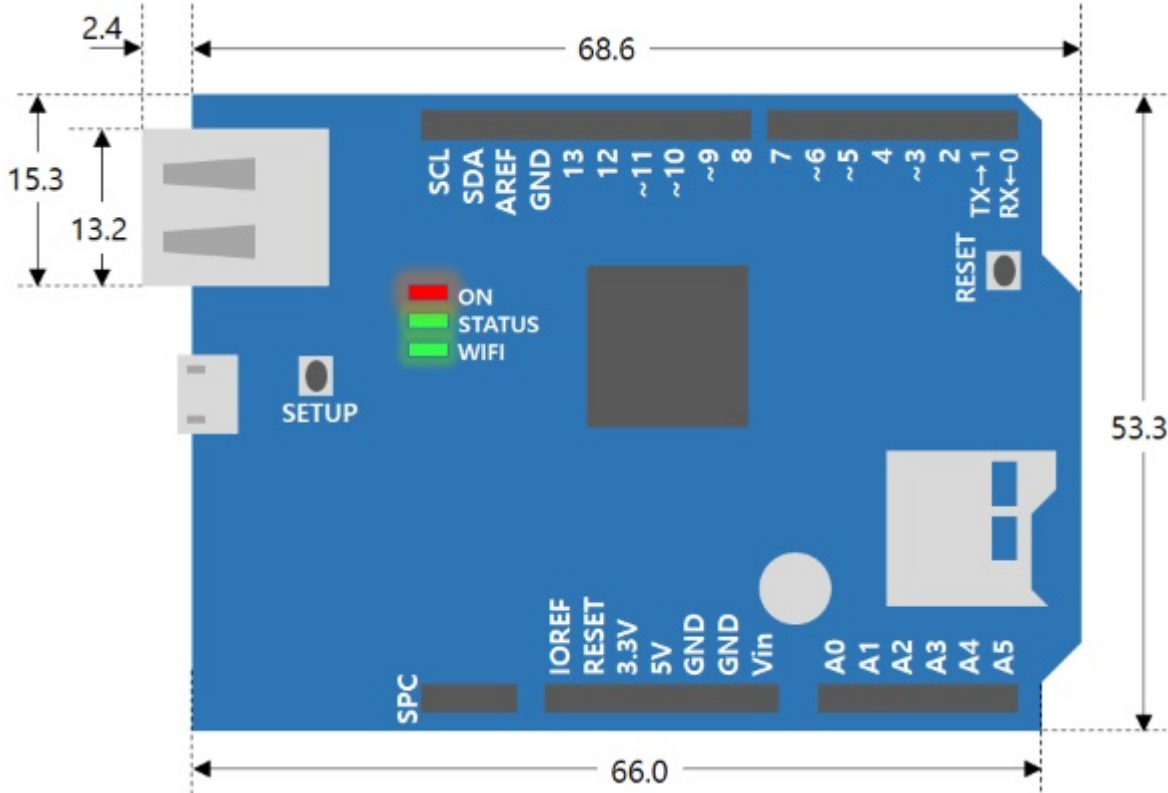

Weight

The weight is about 23.9g(without USB Wireless LAN dongle).

Communication with Arduino

PHPoC Shield for Arduino communicates to Arduino via SPI through ICSP header. SPI interface of the Arduino Uno and Mega is as follows:

Pin	Uno	Mega
MOSI	11	51
MISO	12	50
CLK	13	52
SS	10	10

On the Mega, the pin 53 must be kept as an output or the SPI interface won't work.

Connectors & Components

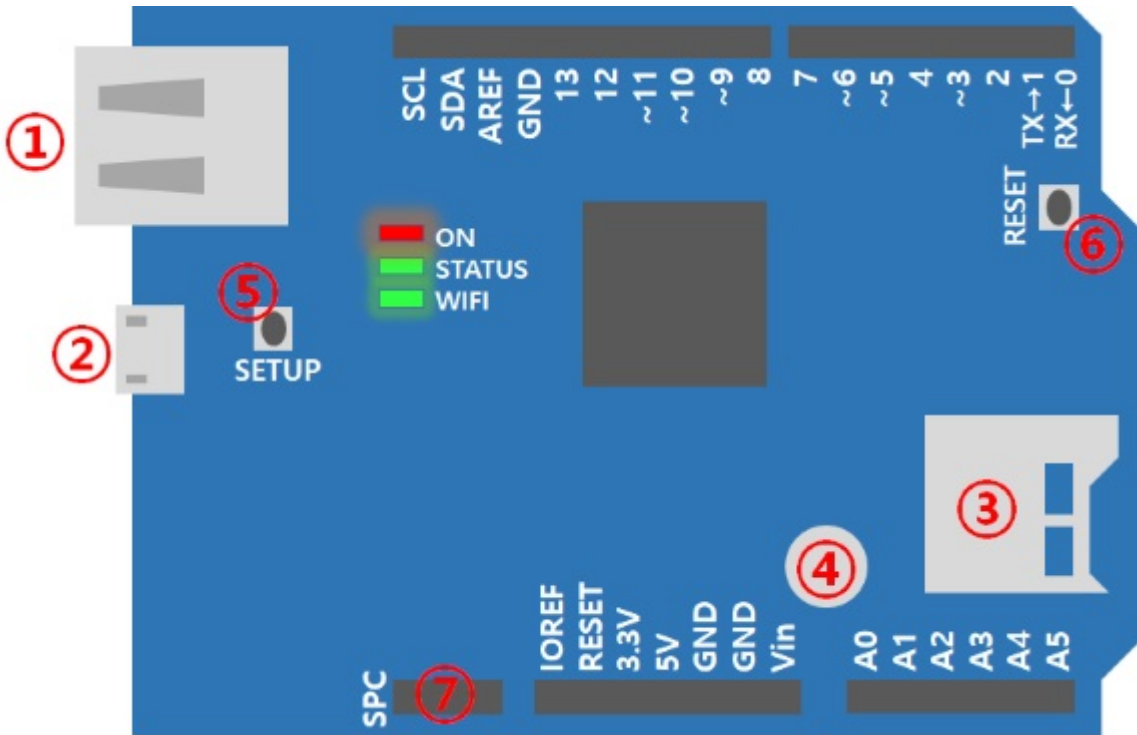

1. USB Port

It supports IEEE 802.11b/g wireless LAN. Connect a USB WIFI dongle to this port.

You must use a USB WIFI dongle equipped with Ralink RT3070 or RT5370 chipset.

2. Micro USB Port

It is a reserved port.

3. MicroSD Socket

It provides a microSD card socket. Arduino directly communicates with SD memory through SPI. The SS pin of SPI for selecting SD memory communication is 4.

4. Built-in Battery

It provides a built-in battery for RTC features and saving log information.

5. SETUP Button

It is used to change or to initialize environment values to default value.

6. RESET Button

This button is for product reset.

7. SPC Port

It is for communication with smart expansions for PHPoC shields.

LED Indicators

This shield has 3 LEDs to indicate the status.

- ON: shows that power is being supplied to the shield
- STATUS: indicates the operating state of the shield
 - Operation - toggle ON/OFF with the same duration
 - Others - blinks every second
- WIFI: indicates the wireless LINK state; blinks during data transmission/reception

Schematic

This is the schematic of P4S-347-R2.

- the schematic of P4S-347-R2 : [P4S-347-R2-PO.pdf](#)

First Use (Web Serial Monitor)

The following is the process of monitoring the serial port of the Arduino using a mobile. If you are new to PHPoC Shield for Arduino, do step by step.

First Use

1. Connect the shield to your Arduino.

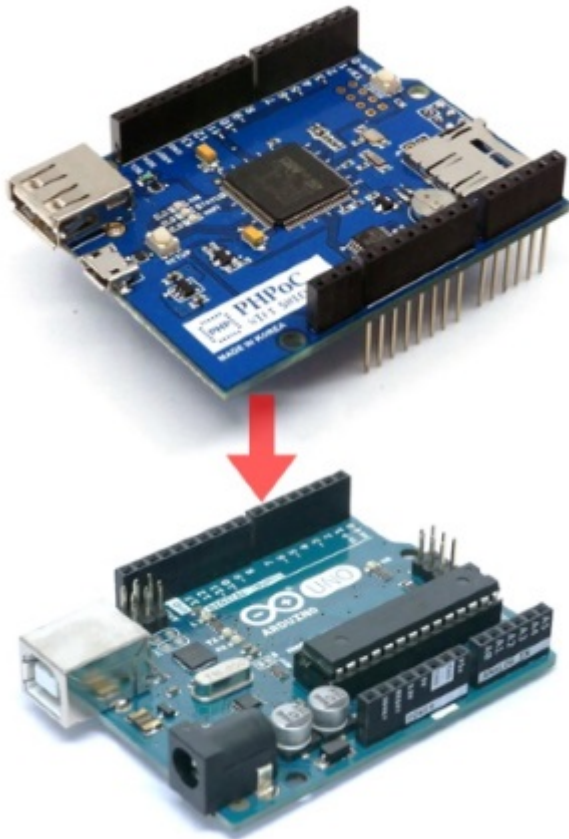

2. Insert a USB Wi-Fi dongle to the shield.

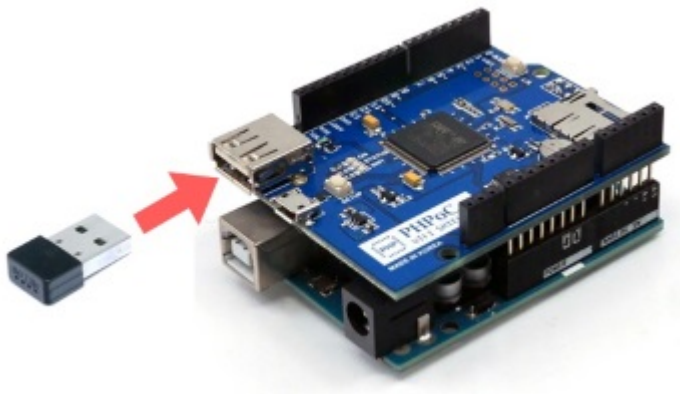

3. Connect the Arduino to your PC with a USB cable.



4. Run Arduino IDE on your PC.



5. Write a sketch below

```
void setup(){
  Serial.begin(9600);
}

void loop(){
  Serial.println("Hello PHPoC Shield for Arduino!");
  delay(1000);
}
```

6. Upload the sketch to your Arduino.



7. With your mobile, connect to the wireless network starting with "phpoc_".



8. Run a web browser once it is properly connected to the wireless LAN.



9. Connect to the shield by entering "192.168.0.1" in the address bar.

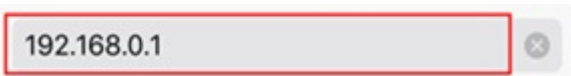

10. Select "Web Serial Monitor" on the main page.



11. Press the "Connect" button.



12. Once the connection is established, you can monitor the serial port of Arduino.

Web Serial Monitor

```
Hello PHPoC Shield for Arduino!  
Hello PHPoC Shield for Arduino!  
Hello PHPoC Shield for Arduino!  
Hello PHPoC Shield for Arduino!
```

[HOME](#) **WebSocket CONNECTED** [SETUP](#)

Set for the First Time

The existing Arduino Ethernet and WIFI shields set IP address and MAC address in the source codes. Unlike those shields, P4S-347-R2 provides a function which manages environment parameters related to the network of the shield itself.

Here is how to set up parameters related to wired/wireless network on PHPoC Shield for Arduino for the first time. A mobile phone or a laptop is required for the settings.

Set for The First Time

1. Connect the shield to your Arduino.

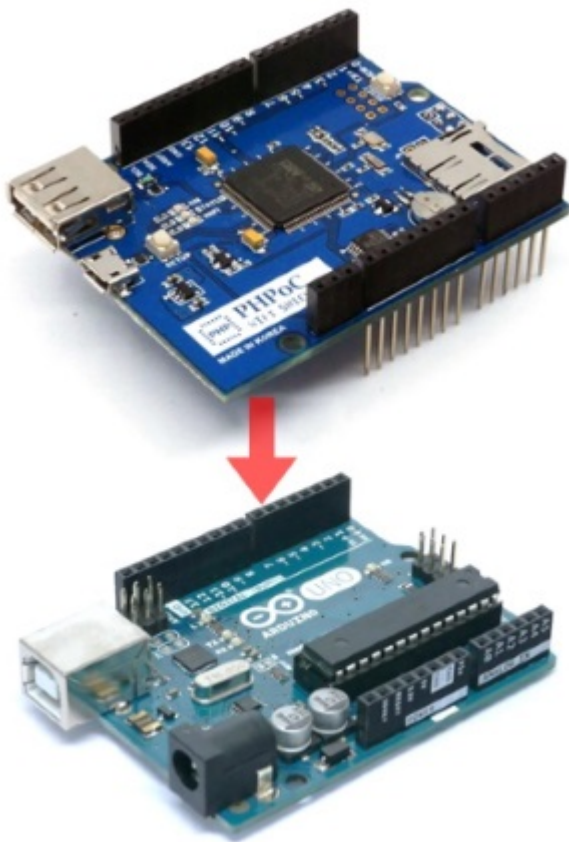

2. Input power to the Arduino.



3. Insert a USB WIFI dongle to the shield.



4. Push SETUP button on the shield once.



5. With your mobile(or laptop), connect to the wireless network starting with "phpoc_".



6. Run a web browser once it is properly connected to the wireless LAN.



7. Connect to the shield by entering "192.168.0.1" in the address bar.



8. Move to the SETUP page by clicking the "Setup" image.



**PHPoC Shield is running
in SETUP mode.
Web service is not
available except SETUP.**

9. You can set network, time and web application parameters on this page.

PHPoC

SETUP

[HOME](#) **[INFO](#)** [NETWORK](#) [TIME](#) [APP](#)

System Information

Product name	PHPoC WiFi Shield 2
MAC address	00:30:f9:02:04:47
Firmware name	p4s_347_1.5.0.poc
Firmware version	1.5.0

Network Information

IPv4	IP address	192.168.0.1
	Subnet mask	255.255.0.0
	Gateway	0.0.0.0
	DNS Server	192.168.0.1
IPv6	Link Local	::0
	Global	::0 / 0
	Gateway	::0
	DNS Server	::0

Wireless LAN Information

Connecting to an AP

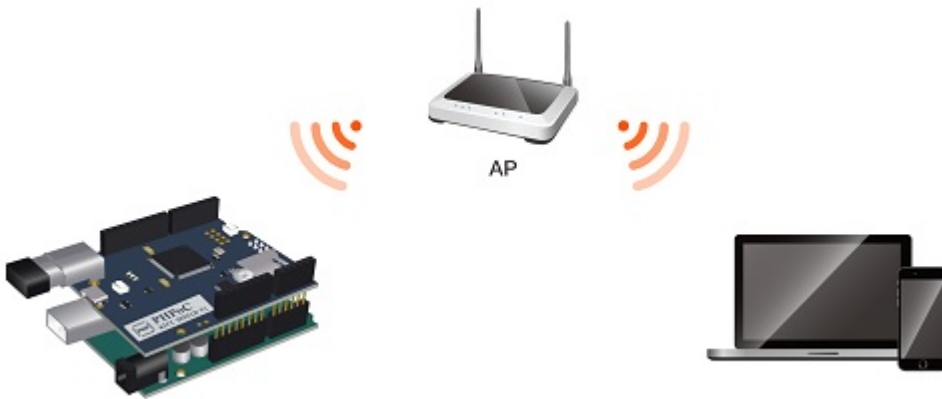

Infrastructure mode is the most common wireless LAN mode that connects wireless networks around an AP(Access Point). Set this mode to connect the shield to your local network or the Internet.

Connect Shield to an AP

1. Connect to the web setup page of shield according to the instructions of [Set for the First Time](#).



**PHPoC Shield is running
in SETUP mode.
Web service is not
available except SETUP.**

2. Move to the SETUP page.

PHPoC

SETUP

HOME
INFO
NETWORK
TIME
APP

System Information

Product name	PHPoC WiFi Shield 2
MAC address	00:30:f9:02:04:47
Firmware name	p4s_347_1.5.0.poc
Firmware version	1.5.0

Network Information

IPv4	IP address	192.168.0.1
	Subnet mask	255.255.0.0
	Gateway	0.0.0.0
	DNS Server	192.168.0.1
IPv6	Link Local	::0
	Global	::0 / 0
	Gateway	::0
	DNS Server	::0

Wireless LAN Information

3. Click the [NETWORK] > [Wi-Fi] menu.



4. Press the [Search] button of [SSID] after selecting the [Wi-Fi Mode] to [Infrastructure].



5. Choose an AP on the list and press the [Select] button.

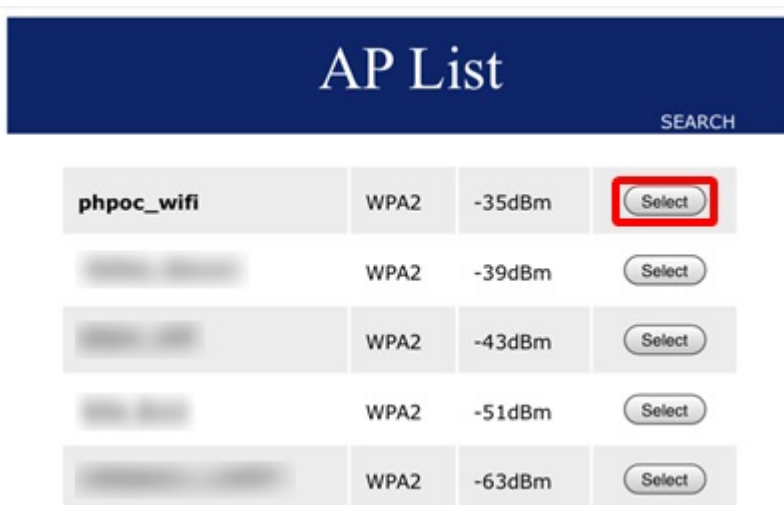

6. Input the Wi-Fi password to the [Shared Key] box and click the [SAVE].

PHPoC

SETUP

HOME INFO NETWORK TIME APP **SAVE**

- ▶ IPv4
- ▶ IPv6
- ▼ Wi-Fi
 - Wi-Fi Enable Disable
 - Wi-Fi Mode Ad-hoc Infrastructure Soft AP
 - Channel Auto
 - SSID phpoc_wifi
 - Shared Key hide key
 - 802.1x None

7. Setting is done if the message is shown.

IP address may be changed. Please check newly assigned IP address from PHPoC Debugger and reconnect to the device.

setup complete

Refer to the instruction of [Manual IP setup](#), if you want to use a static IP address.

Operating as an AP



To operate the shield as an AP, you must set the wireless LAN mode to Soft AP. Soft AP is a mode for creating a 1: 1 wireless network between a mobile device (or laptop) and a shield. The shield acts like an AP when in this mode, so you can connect your mobile device with a shield via wireless LAN.

※Caution : You CANNOT connect the shield to the Internet in this mode. When you want to connect your shield to the Internet, follow the instruction of [Connecting to an AP](#).

Operating as an AP

1. Connect to the web setup page of shield according to the instructions of [Set for the First Time](#).



**PHPoC Shield is running
in SETUP mode.
Web service is not
available except SETUP.**

2. Move to the SETUP page.

The screenshot displays the 'SETUP' interface for a PHPoC device. The top navigation bar includes 'HOME', 'INFO' (selected), 'NETWORK', 'TIME', and 'APP'. The main content is divided into three sections: System Information, Network Information, and Wireless LAN Information.

System Information

Product name	PHPoC WiFi Shield 2
MAC address	00:30:f9:02:04:47
Firmware name	p4s_347_1.5.0.poc
Firmware version	1.5.0

Network Information

IPv4	IP address	192.168.0.1
	Subnet mask	255.255.0.0
	Gateway	0.0.0.0
	DNS Server	192.168.0.1
IPv6	Link Local	::0
	Global	:::0 / 0
	Gateway	:::0
	DNS Server	:::0

Wireless LAN Information

3. Click the [NETWORK] > [Wi-Fi] menu.



4. Press the [Search] button of [Channel] after selecting the [Wi-Fi Mode] to [Soft AP].

PHPoC

SETUP

HOME INFO **NETWORK** TIME APP SAVE

▶ IPv4

▶ IPv6

▼ Wi-Fi

Wi-Fi Enable
 Disable

Wi-Fi Mode Ad-hoc
 Infrastructure
 Soft AP

Channel Auto

SSID phpoc_020447

Shared Key
 hide key

802.1x None

5. Choose a channel which is not busy on the list and press the [Select] button.

Channel List

SEARCH

Channel 1	21-240270, 409, 2401	<input type="button" value="Select"/>
Channel 2	210120, Sollae, Warehouse	<input type="button" value="Select"/>
Channel 3		<input style="border: 2px solid red;" type="button" value="Select"/>
Channel 4	213 10, 409	<input type="button" value="Select"/>
Channel 5	21-240270, 409, 2401	<input type="button" value="Select"/>
Channel 6	213 10, 409	<input type="button" value="Select"/>
Channel 7	21-240270, 409, 2401	<input type="button" value="Select"/>
Channel 8	210120, Sollae, Warehouse	<input type="button" value="Select"/>
Channel 9	21-240270, 409, 2401	<input type="button" value="Select"/>
Channel 10	210120, Sollae, Warehouse	<input type="button" value="Select"/>
Channel 11		<input type="button" value="Select"/>
Channel 12		<input type="button" value="Select"/>
Channel 13	21-240270, 409, 2401	<input type="button" value="Select"/>
Channel 14		<input type="button" value="Select"/>

6. Input a name of wireless LAN in [SSID] box and click the [SAVE].



The screenshot shows the 'SETUP' interface for a device labeled 'PHPoC'. The navigation menu includes 'HOME', 'INFO', 'NETWORK', 'TIME', and 'APP'. A 'SAVE' button is highlighted with a red box. The 'Wi-Fi' section is expanded, showing the following settings:

- Wi-Fi:** Enable, Disable
- Wi-Fi Mode:** Ad-hoc, Infrastructure, Soft AP
- Channel:** 3 (dropdown), Search
- SSID:** phpoc (text input, highlighted with a red box), Search
- Shared Key:** (text input), hide key
- 802.1x:** None (dropdown)

7. Setting is done if the message is shown.

IP address may be changed. Please check newly assigned IP address from PHPoC Debugger and reconnect to the device.

setup complete

8. Search the SSID and connect your mobile to it.

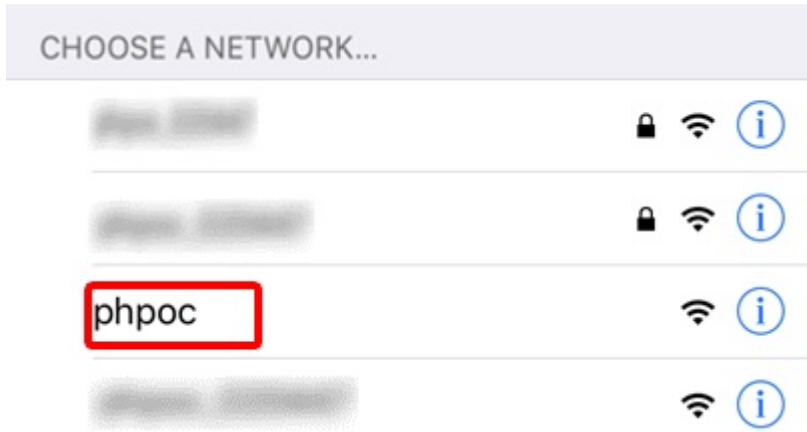

9. Run a web browser and connect to 192.168.0.1.

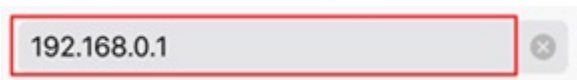

Auto IP Address

If there is a device assigning the IP address such as router on your local network, the shield can be automatically assigned an IP address.

1. Connect to the web setup page of shield



Setup



Web Serial **Monitor**

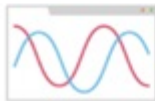

Web Serial **Plotter**

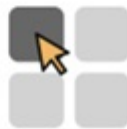

Web Remote **Push**

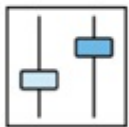

Web Remote **Slide**

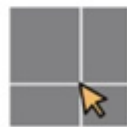

Web Remote **Pad**

2. Move to the SETUP page.

The screenshot displays the 'SETUP' interface for a PHPoC device. The top navigation bar includes 'HOME', 'INFO' (selected), 'NETWORK', 'TIME', and 'APP'. The main content is divided into three sections: System Information, Network Information, and Wireless LAN Information.

System Information

Product name	PHPoC WiFi Shield 2
MAC address	00:30:f9:02:04:47
Firmware name	p4s_347_1.5.0.poc
Firmware version	1.5.0

Network Information

IPv4	IP address	192.168.0.1
	Subnet mask	255.255.0.0
	Gateway	0.0.0.0
	DNS Server	192.168.0.1
IPv6	Link Local	::0
	Global	::0 / 0
	Gateway	::0
	DNS Server	::0

Wireless LAN Information

3. Click the [NETWORK] > [IPv4] menu.



4. Select the [IP Address Type] to [Auto IP Address] and click the [SAVE].



The screenshot shows the PHPoC SETUP interface. At the top right, it says 'PHPoC'. The main title is 'SETUP'. Below the title are navigation tabs: 'HOME', 'INFO', 'NETWORK' (which is highlighted), 'TIME', and 'APP'. A red box highlights the 'SAVE' button in the top right corner. Under the 'NETWORK' tab, there is a section for 'IPv4' settings. The 'IP Address Type' is set to 'Auto IP Address', which is also highlighted with a red box. Below this are input fields for 'IP Address', 'Subnet Mask', 'Gateway', and 'DNS Server', all containing '0.0.0.0'. There are also expandable sections for 'IPv6' and 'Wi-Fi'.

5. After rebooting for finishing the settings, the shield will be assigned an IP address.

IP address may be changed. Please check newly assigned IP address from PHPoC Debugger and reconnect to the device.

setup complete

6. To confirm the assigned IP address, follow the instructions of [Verifying the IP Address](#).

Static IP Address

You can set a static IP address to the shield as follows:

1. Connect to the web setup page of shield



Setup



Web Serial **Monitor**

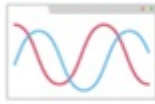

Web Serial **Plotter**

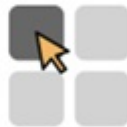

Web Remote **Push**

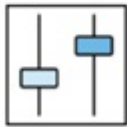

Web Remote **Slide**

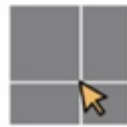

Web Remote **Pad**

2. Move to the SETUP page.

The screenshot displays the 'SETUP' interface for a PHPoC device. The top navigation bar includes 'HOME', 'INFO' (selected), 'NETWORK', 'TIME', and 'APP'. The main content is divided into three sections: 'System Information', 'Network Information', and 'Wireless LAN Information'.

System Information

Product name	PHPoC WiFi Shield 2
MAC address	00:30:f9:02:04:47
Firmware name	p4s_347_1.5.0.poc
Firmware version	1.5.0

Network Information

IPv4	IP address	192.168.0.1
	Subnet mask	255.255.0.0
	Gateway	0.0.0.0
	DNS Server	192.168.0.1
IPv6	Link Local	::0
	Global	::0 / 0
	Gateway	::0
	DNS Server	::0

Wireless LAN Information

3. Click the [NETWORK] > [IPv4] menu.



4. Select the [IP Address Type] to [Static IP Address].

PHPoC

SETUP

HOME INFO **NETWORK** TIME APP SAVE

▼ IPv4

IP Address Type Auto IP Address **Static IP Address**

IP Address

Subnet Mask

Gateway

DNS Server

▶ IPv6

▶ Wi-Fi

5. Input an IP address, a Subnet mask, a Gateway IP address and a DNS IP address and click the [SAVE].



PHPoC

SETUP

HOME INFO NETWORK TIME APP **SAVE**

▼ IPv4

IP Address Type

Auto IP Address

Static IP Address

IP Address 192.168.0.250

Subnet Mask 255.255.255.0

Gateway 192.168.0.1

DNS Server 192.168.0.1

▶ IPv6

▶ Wi-Fi

The IP address must be unique within the network. If you connect the shield to a public network, please make sure whether IP address is already in use or not. If there is a manager in charge of IP address assignment on your network, we recommend to get assistance from the manager.

6. Once the setup is completed, the web browser will be reconnected to its IP address.

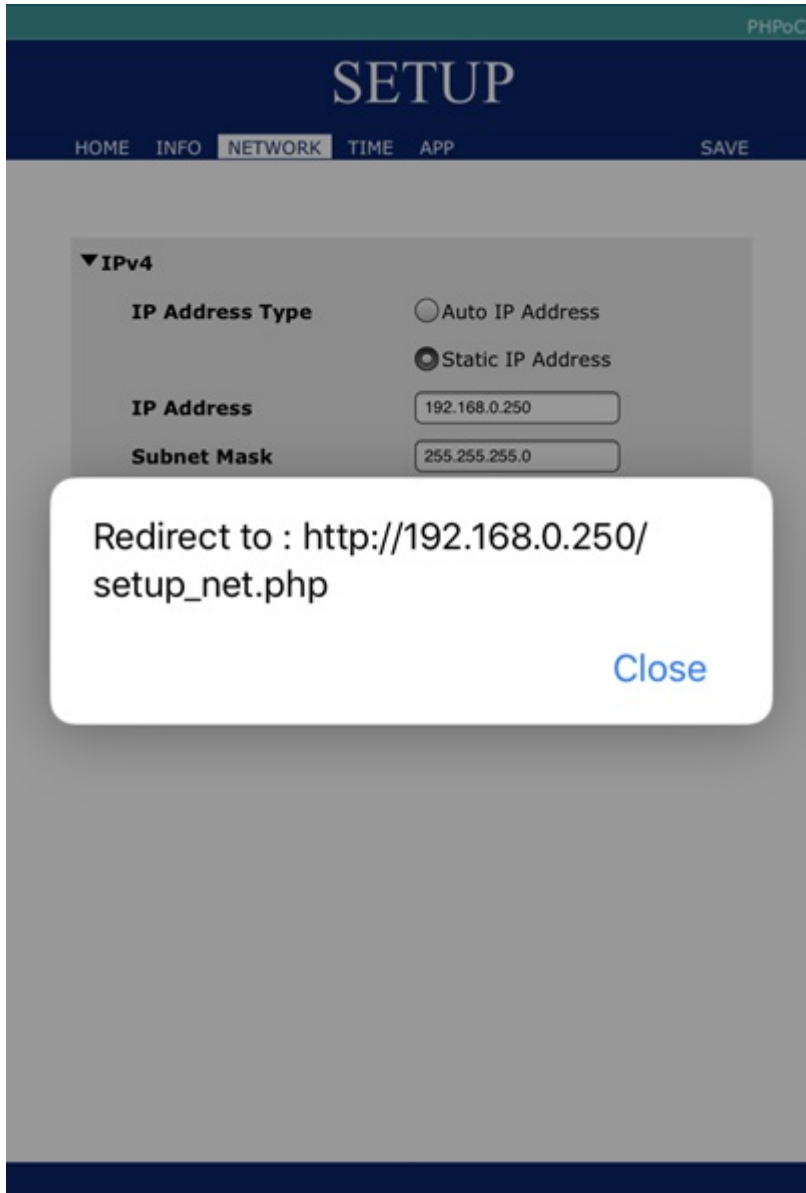

Verifying the IP Address

1. Connect a shield to your network.
2. Run the Arduino IDE.



3. Input the code as follows:

```
#include <Phpoc.h>

void setup() {
  Serial.begin(9600);
  while(!Serial)
    ;

  Phpoc.begin(PF_LOG_NET);
}

void loop() {
}
```

4. Upload the code to Arduino.



5. Run the serial monitor.



6. Verify the IP address shown on the serial monitor.

```
log> sppc_begin: phpoc wifi shield 2, firmware 1.5.0
log> sppc_begin: package 1.5.0
log> sppc_begin: WiFi AP phpoc_020447 ch8
log> sppc_begin: IPv4 192.168.0.1 255.255.0.0 0.0.0.0 192.168.0.1
```

Library Overview

PHPoC Library

PHPoC Library is a library for Arduino which is provided for users to easily use many functions of PHPoC shields. By using the library, you can implement many functions as follows:

- TCP Client
- TCP Server: web socket and TELNET server
- sending an E-mail
- setting Time

PHPoC Expansion Library

PHPoC Expansion Library is a library for Arduino which is provided for users to use smart expansion boards for Shield 2.

※ [What is smart expansion boards for shield 2?](#)

Installing Library

You can install the PHPoC library via Arduino IDE.

1. Run the Arduino IDE.



2. Click the [Sketch] > [Include Library] > [Manage Libraries...] menu.

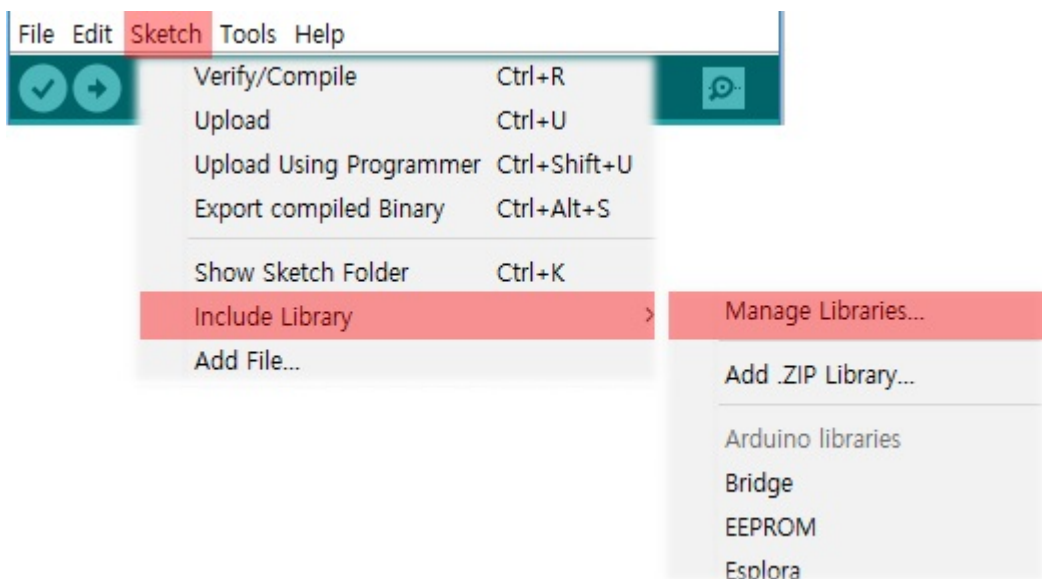

3. Search "phpoc" on the Library Manager.

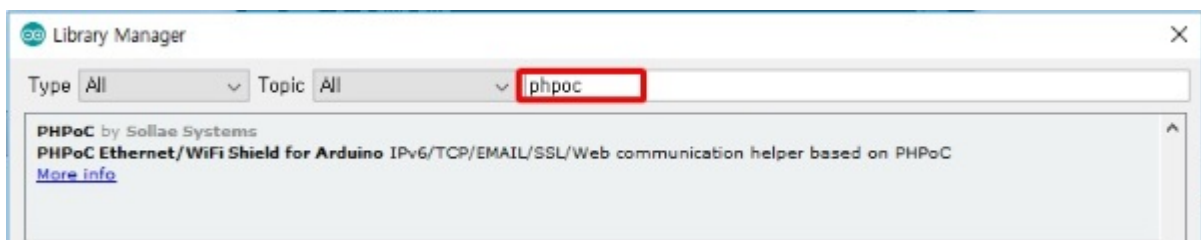

4. Select the PHPoC library and press the [Install] button.

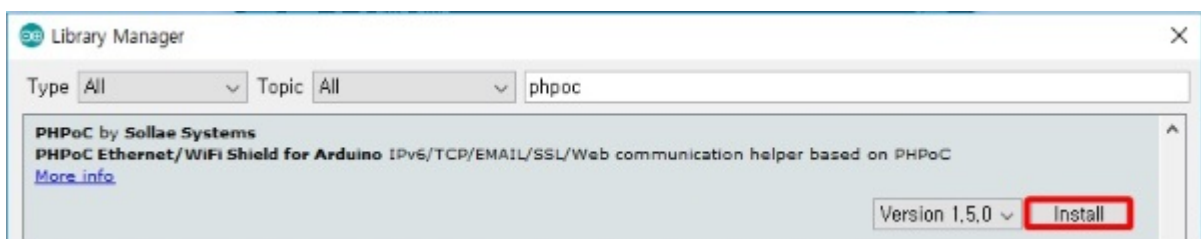

"INSTALLED" message will appear on success.

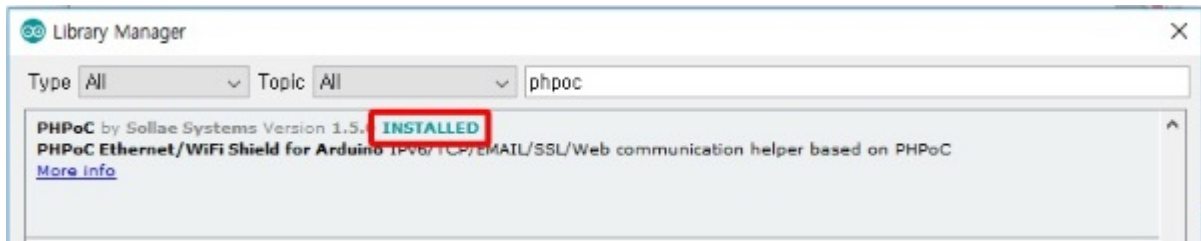

5. Confirm the "PHPoC" in the [Sketch] > [Include Library] > [Contributed libraries].

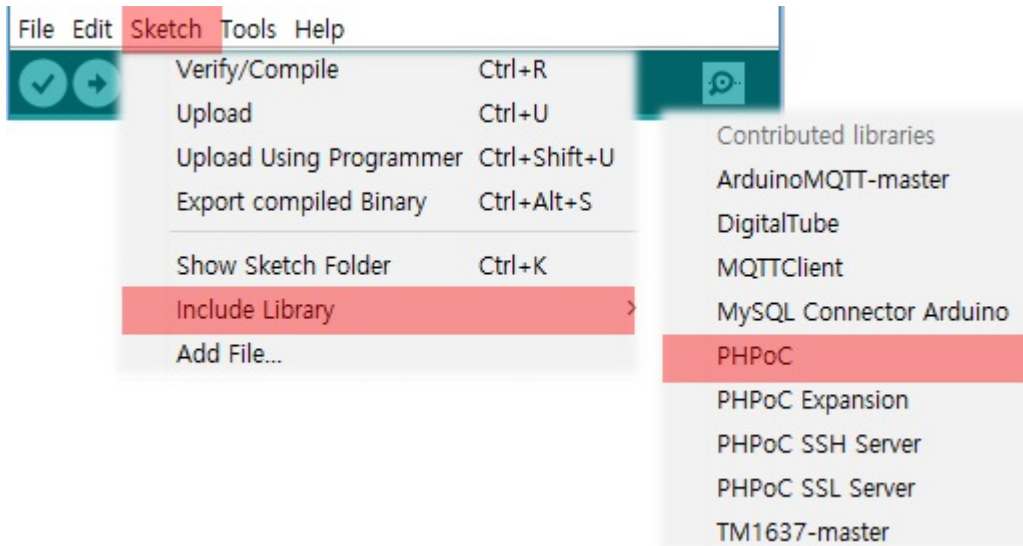

6. Confirm the "PHPoC" in the [File] > [Examples] > [Examples from Custom Libraries].

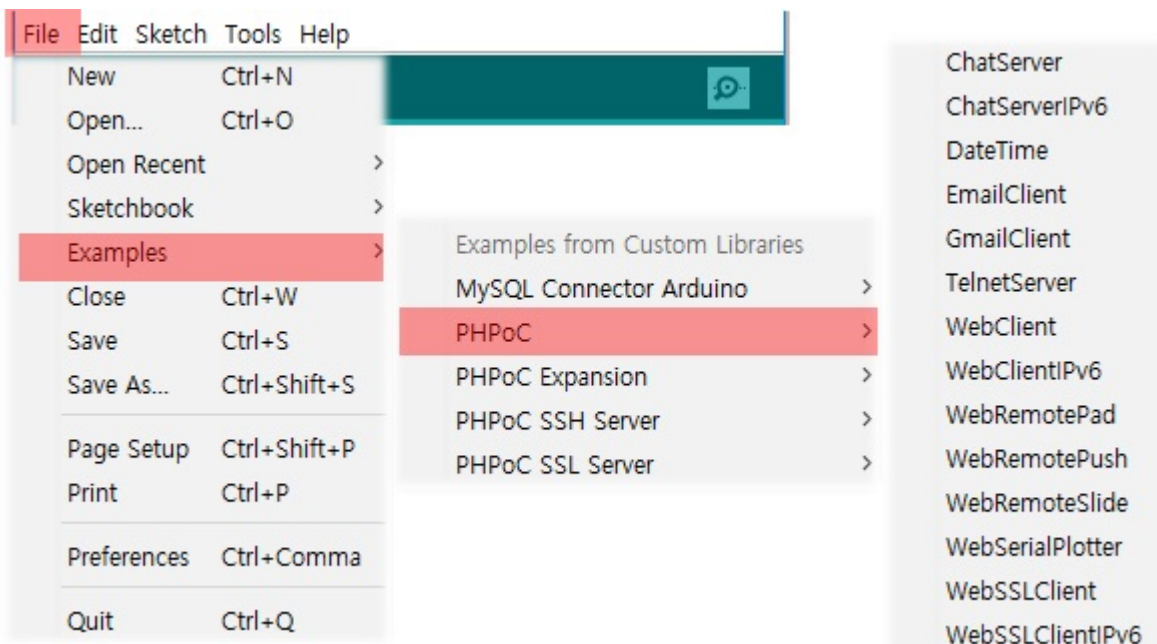

7. To run the examples of PHPoC library, follow the instructions of [Using the Example](#).

※ Note : PHPoC Expansion library can be installed in the same way.

Using Examples

Examples included in the PHPoC library can be run via Arduino IDE. Here is the procedure for running the Web Client. Note that you need to connect your shield to the Internet before running this example.

1. Connect your shield to an AP which has the Internet connectivity according to the instructions of [Connecting to an AP](#).
2. Install the PHPoC library according to the instructions of [Installing The Library](#).
3. Run the Aduino IDE and select [File] > [Examples] > [PHPoC] > [WebClient].

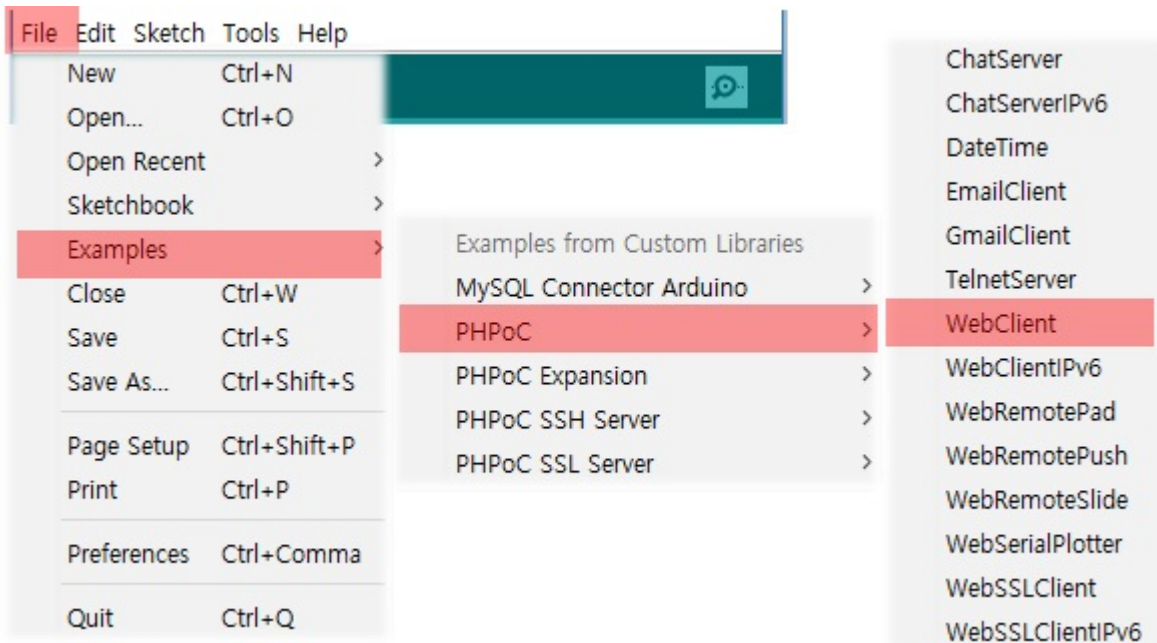

4. Upload the example.



5. Run the serial monitor.



6. Check the result shown in the serial monitor.

Web Serial Monitor

Serial monitor is a function that is provided by Arduino IDE. This shield provides web serial monitor which is the web based serial monitor. Because this function is web based, you just need a web browser instead of USB connection to use this function.

Using Web Serial Monitor

1. Connect a shield to your local network.
2. Install the PHPoC library follow the instructions of [Installing the Library](#).
3. Run the Arduino IDE.



4. Input the code as follows:

```
void setup(){
  Serial.begin(9600);
}

void loop(){
  Serial.println("Hello PHPoC Shield for Arduino!");
  delay(1000);
}
```

5. Upload the code.

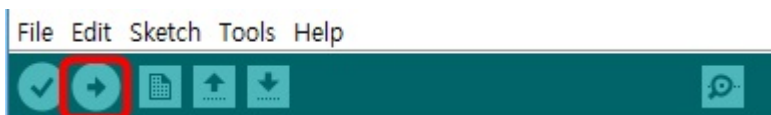

6. Run the serial monitor.



7. Check the messages on the serial monitor.

```

Hello PHPoC Shield for Arduino!
Hello PHPoC Shield for Arduino!
Hello PHPoC Shield for Arduino!
Hello PHPoC Shield for Arduino!
Hello PHPoC Shield for Arduino!
Hello PHPoC Shield for Arduino!
Hello PHPoC Shield for Arduino!
Hello PHPoC Shield for Arduino!
Hello PHPoC Shield for Arduino!
Hello PHPoC Shield for Arduino!
Hello PHPoC Shield for Arduino!
Hello PHPoC Shield for Arduino!
Hello PHPoC Shield for Arduino!
Hello PHPoC Shield for Arduino!

```

8. Run a web browser on your mobile or PC and connect to the web page of the shield.

192.168.0.1

Follow the instruction of [Verifying IP Address](#), if you don't know the IP address.

9. Click the [Web Serial Monitor].



Setup



Web Serial **Monitor**



Web Serial **Plotter**



Web Remote **Push**

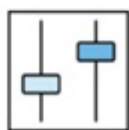

Web Remote **Slide**

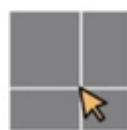

Web Remote **Pad**

10. Click the [Connect] button.

Web Serial Monitor

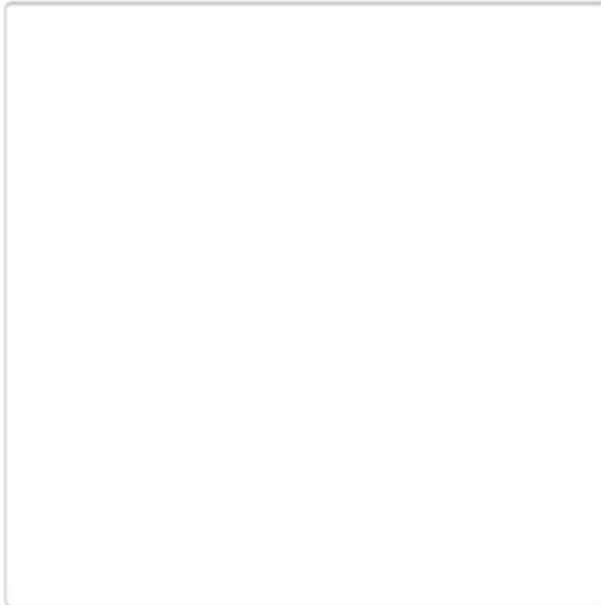

[HOME](#) **WebSocket CLOSED** [SETUP](#)



11. The same messages will be shown with those of the serial monitor.

Web Serial Monitor



[HOME](#) **WebSocket CONNECTED** [SETUP](#)



Web Serial Plotter

Serial plotter is a function that is provided by Arduino IDE. This shield provides web serial plotter which is the web based serial plotter. Because this function is web based, you just need a web browser instead of USB connection to use this function.

Using Web Serial Plotter

1. Connect a shield to your local network.
2. Install the PHPoC library follow the instructions of [Installing the Library](#).
3. Run the Arduino IDE.



4. Load the [WebSerialPlotter] example.

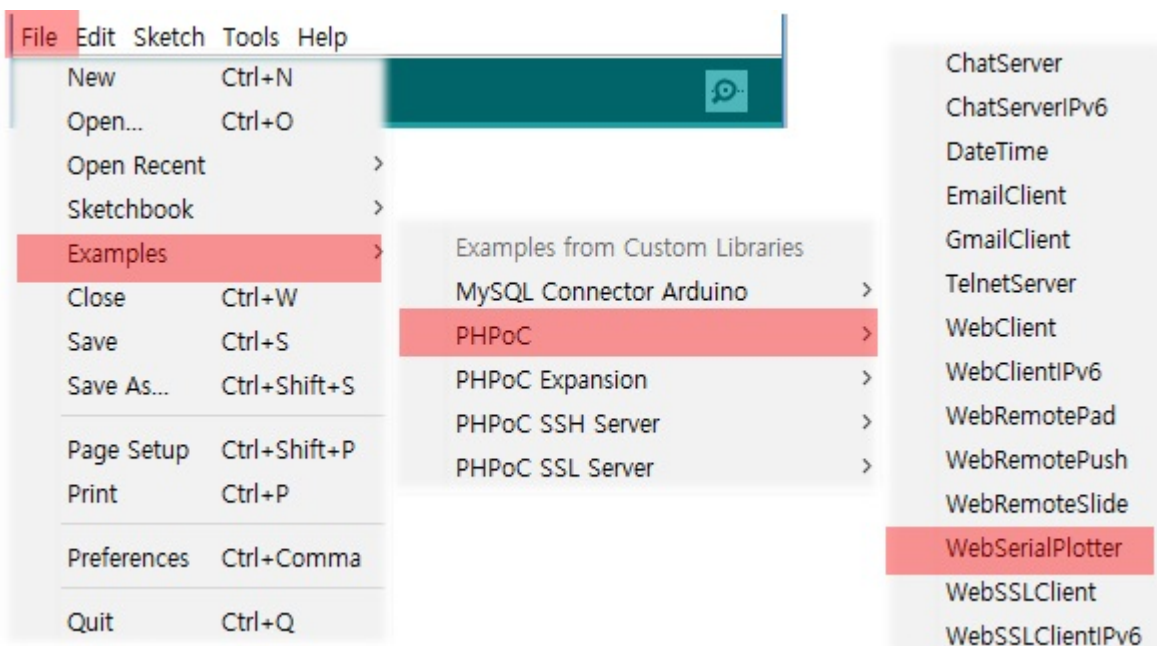

5. Upload the example code.

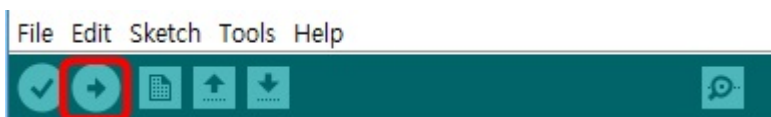

6. Run the serial plotter.

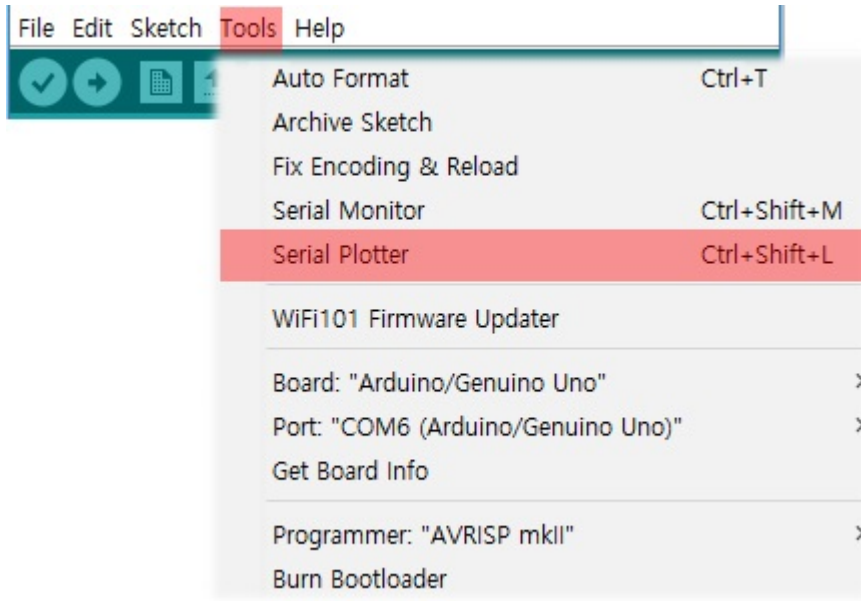

7. Check the result in the serial plotter.

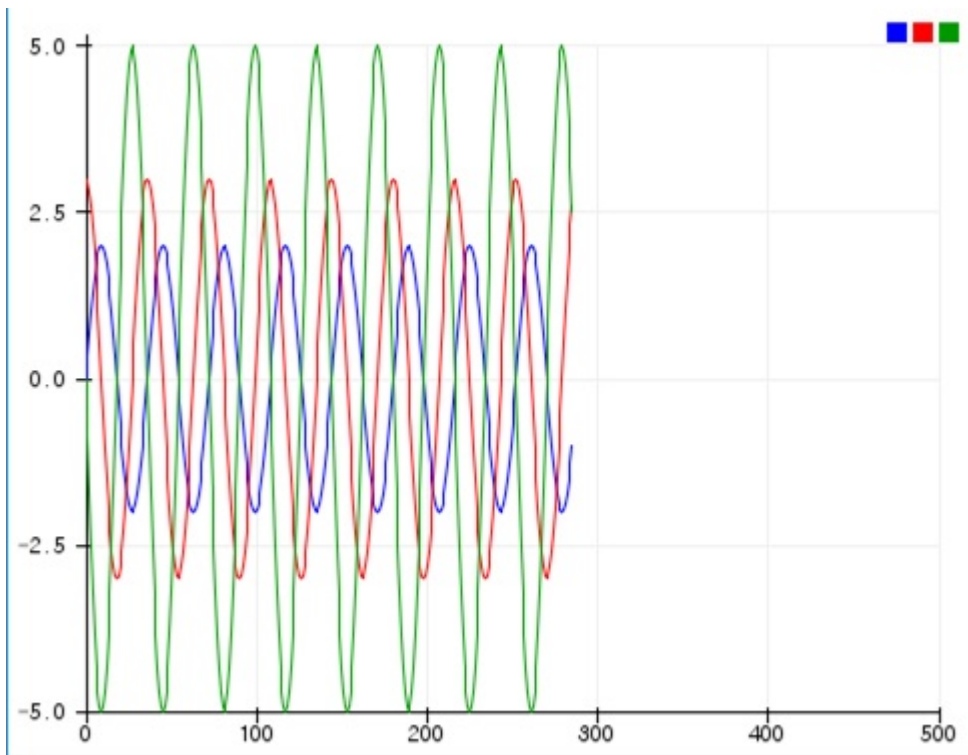

8. Run a web browser on your mobile or PC and connect to the web page of the shield.



Follow the instruction of [Verifying IP Address](#), if you don't know the IP address.

9. Click the [Web Serial Plotter].

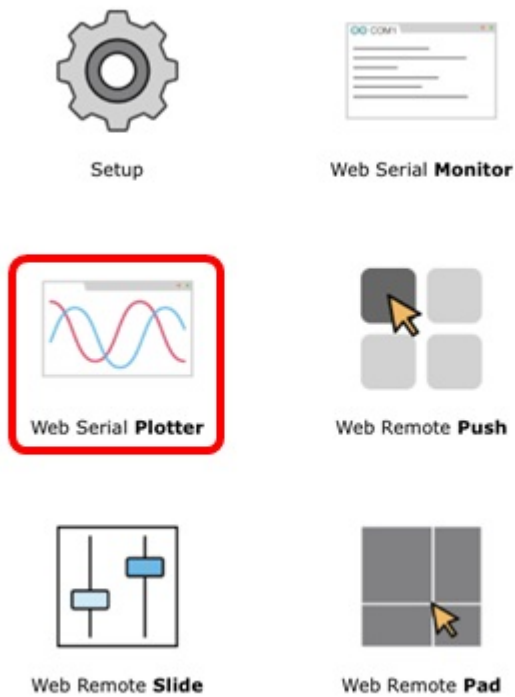

10. Click the [Connect] button.

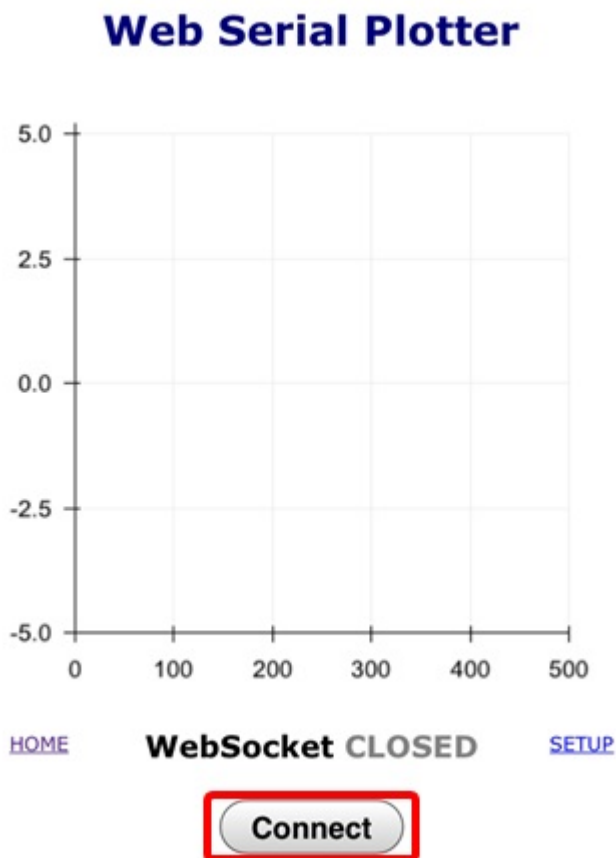

11. The same result will be shown with those of the serial plotter.

Web Serial Plotter

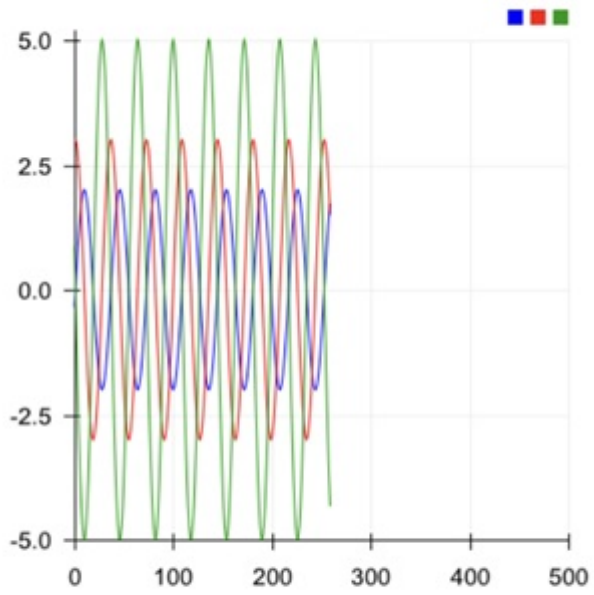

[HOME](#) **WebSocket CONNECTED** [SETUP](#)

Disconnect

Web Remote Control(Push)

Using the web remote control, you can control Arduino remotely by sending specific data to the Arduino on the Web. This application provides sending data by buttons on a web browser to your Arduino.

Using the Web Remote Control(Push)

1. Connect a shield to your local network.
2. Install the PHPoC library follow the instructions of [Installing the Library](#).
3. Run the Arduino IDE.



4. Load the [WebRemotePush] example.

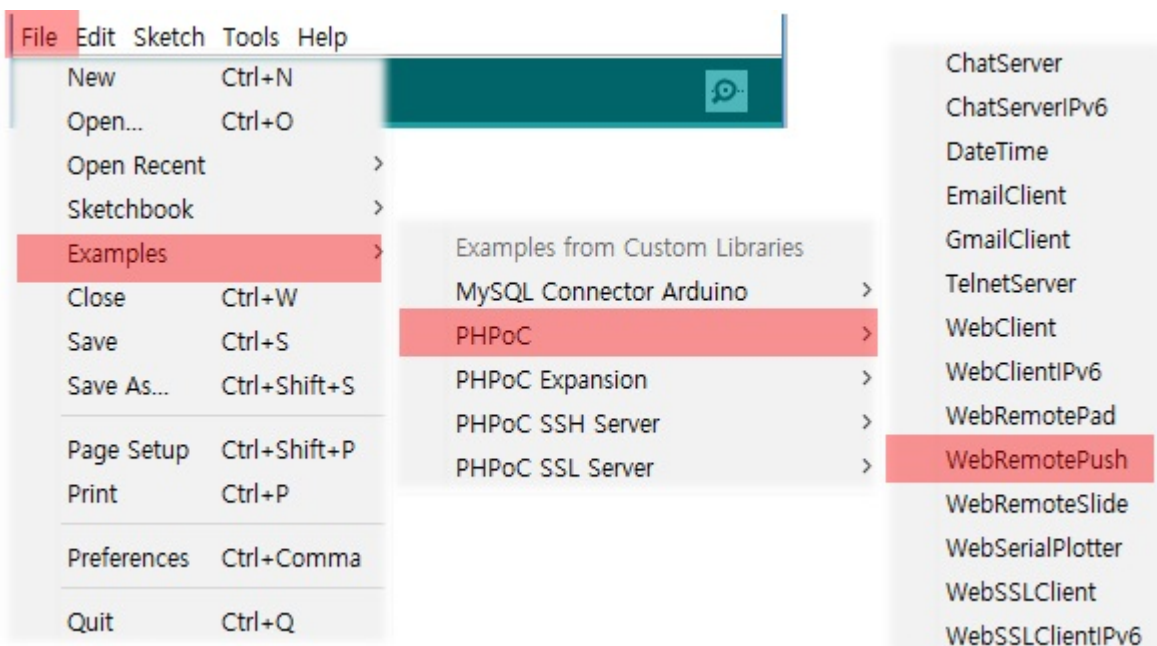

5. Upload the example code.



6. Run the serial monitor.

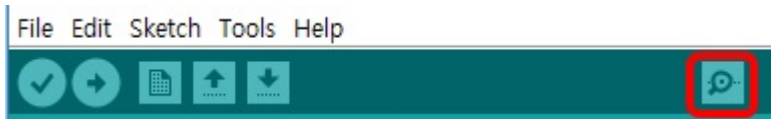

7. Check the IP address of the shield.

```
log> sppc_begin: phpoc wifi shield 2, firmware 1.5.0
log> sppc_begin: package 1.5.0
log> sppc_begin: WiFi AP phpoc_020447 ch2
log> sppc_begin: IPv4 192.168.0.1 255.255.0.0 0.0.0.0 192.168.0.1
log> phpoc_server : listen 2/80
WebSocket server address : 192.168.0.1
```

8. Run a web browser on your mobile or PC and connect to the web page of the shield.

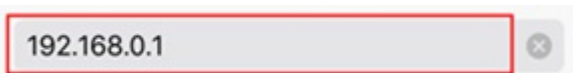

9. Click the [Web Remote Control / Push].



Setup



Web Serial **Monitor**

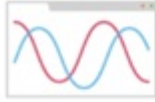

Web Serial **Plotter**



Web Remote **Push**

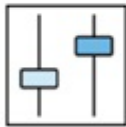

Web Remote **Slide**

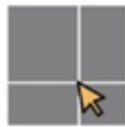

Web Remote **Pad**

10. Click the [Connect] button.

Web Remote Push

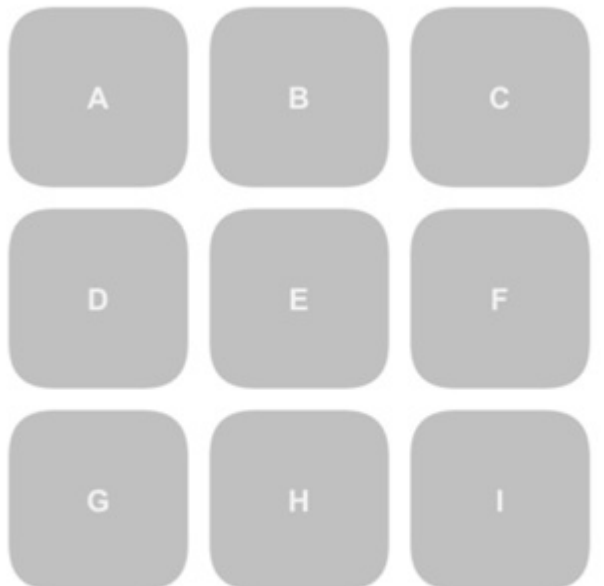

[HOME](#)

WebSocket CLOSED

[SETUP](#)



11. Press any of the A, B and C buttons.

Web Remote Push

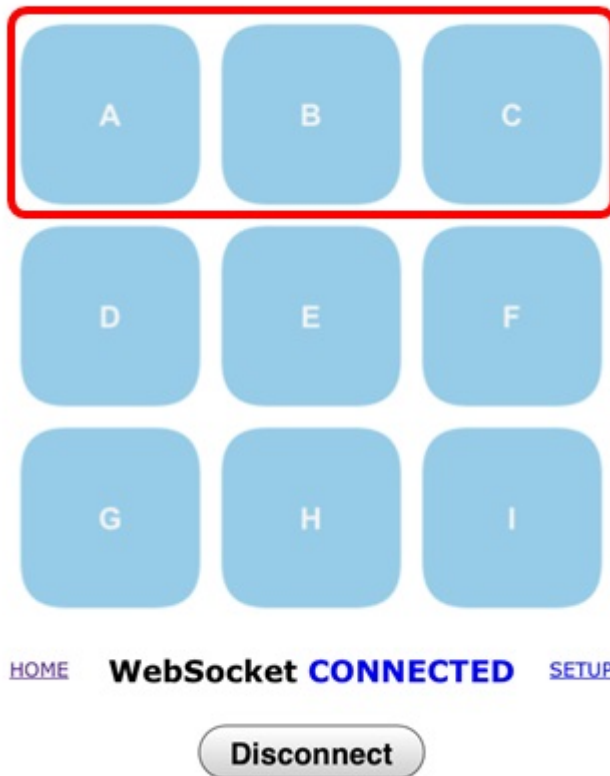

12. Check the messages on the serial monitor.

```
button A release  
button B release  
button C release  
log> phoc_server: connected 3  
log> phoc server : listen 2/80  
button A press  
button A release  
button A press  
button A release
```

This example only processes for these three buttons (A, B, C). Add the rest of buttons to Arduino codes yourself.

Web Remote Control(Slide)

Using the web remote control, you can control Arduino remotely by sending specific data to the Arduino on the Web. This application provides sending data by slide bars on a web browser to your Arduino.

Using Web Remote Control (Slide)

1. Connect a shield to your local network.
2. Install the PHPoC library follow the instructions of [Installing the Library](#).
3. Run the Arduino IDE.



4. Load the [WebRemoteSlide] example.

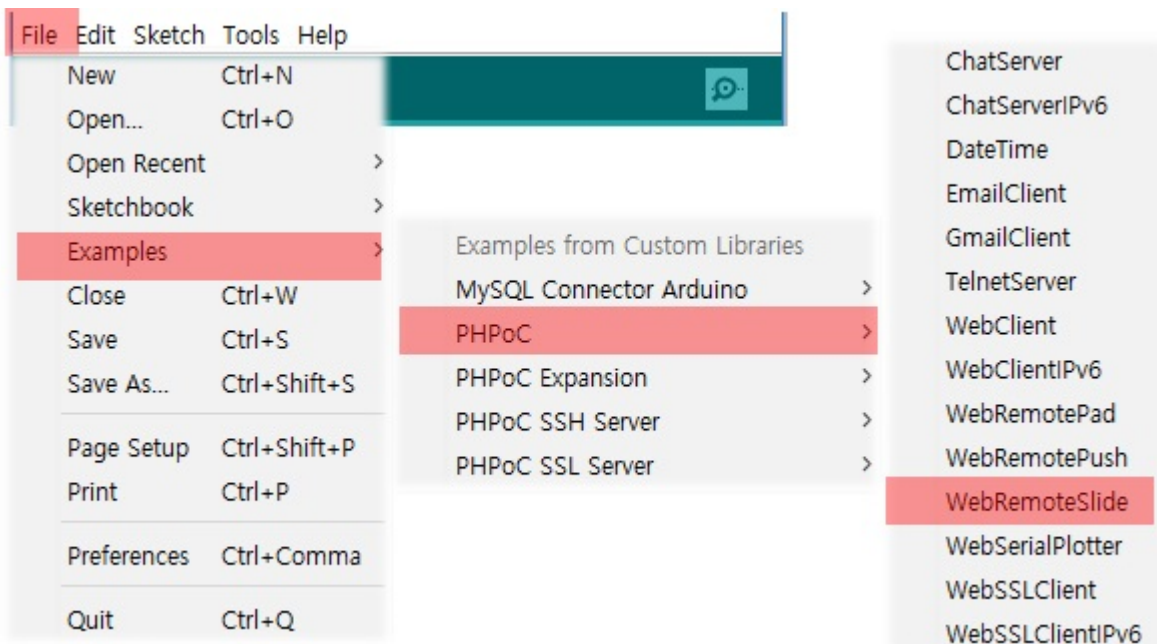

5. Upload the example code.

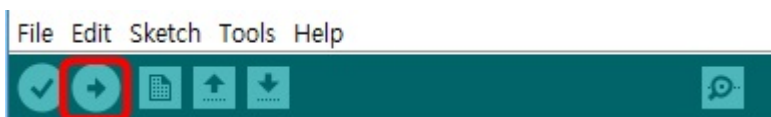

6. Run the serial monitor.

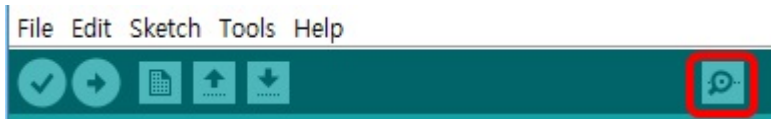

7. Check the IP address of the shield.

```
log> sppc_begin: phpoc wifi shield 2, firmware 1.5.0
log> sppc_begin: package 1.5.0
log> sppc_begin: WiFi AP phpoc_020447 ch2
log> sppc_begin: IPv4 192.168.0.1 255.255.0.0 0.0.0.0 192.168.0.1
log> phpoc_server : listen 2/80
WebSocket server address : 192.168.0.1
```

8. Run a web browser on your mobile or PC and connect to the web page of the shield.

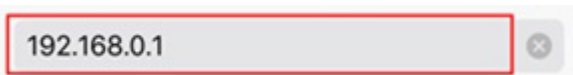

9. Click the [Web Remote Control / Slide].



Setup



Web Serial **Monitor**

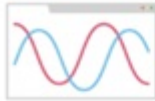

Web Serial **Plotter**

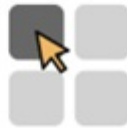

Web Remote **Push**

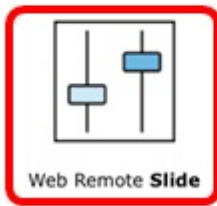

Web Remote **Slide**

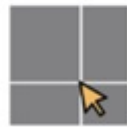

Web Remote **Pad**

10. Click the [Connect] button.

Web Remote Slide

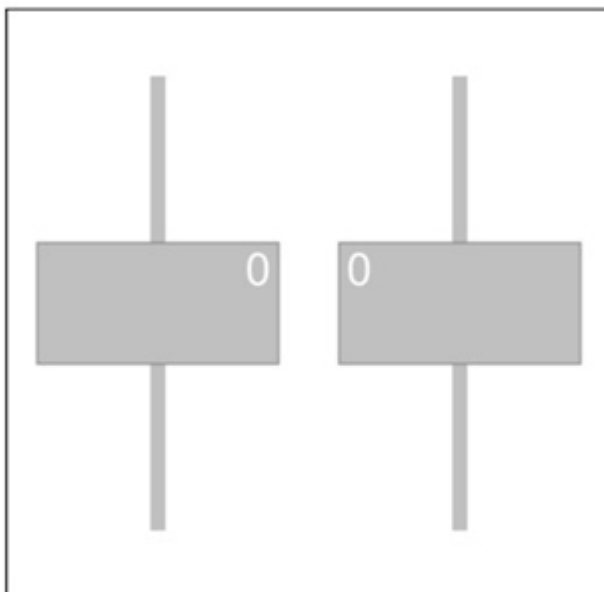

[HOME](#) **WebSocket CLOSED** [SETUP](#)



11. Press any of the A, B and C buttons.

Web Remote Slide

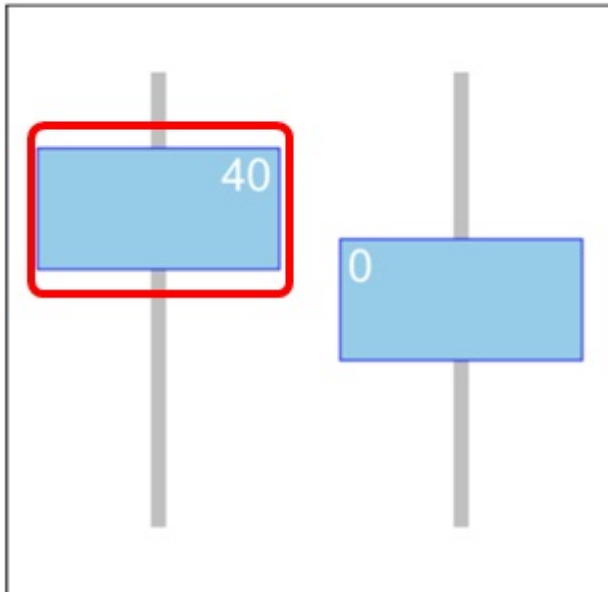

[HOME](#) **WebSocket CONNECTED** [SETUP](#)

Disconnect Return to Center

12. Check the messages on the serial monitor.

```
WebSocket server address : 192.168.0.1
log> ph poc_server: connected 2
log> ph poc_server : listen 3/80
A/5
A/8
A/12
A/15
A/20
A/23
A/27
A/30
A/33
A/36
A/37
A/38
A/39
A/40
```

Web Remote Control(Pad)

Using the web remote control, you can control Arduino remotely by sending specific data to the Arduino on the Web. This application provides sending data by a pad on a web browser to your Arduino.

Using the Web Remote Control(Pad)

1. Connect a shield to your local network.
2. Install the PHPoC library follow the instructions of [Installing the Library](#).
3. Run the Arduino IDE.



4. Load the [WebRemotePad] example.

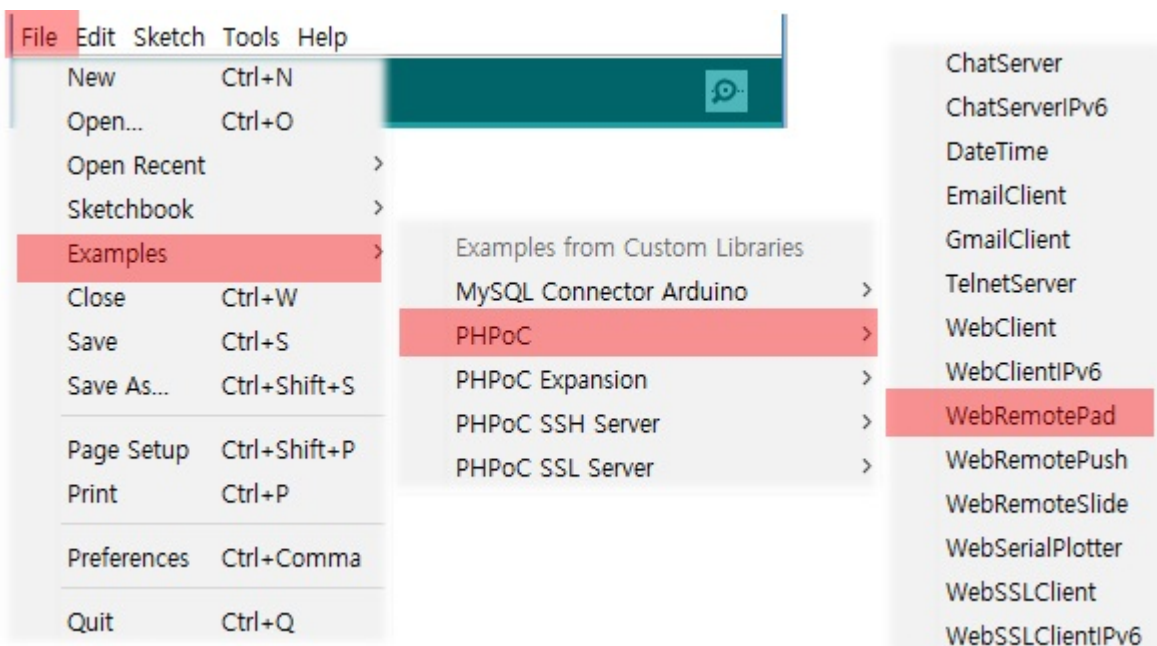

5. Upload the example code.



6. Run the serial monitor.

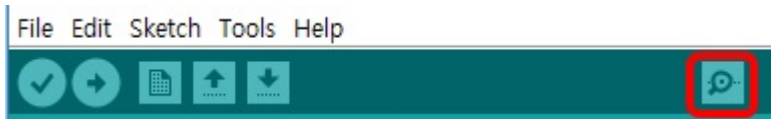

7. Check the IP address of the shield.

```
log> sppc_begin: phpoc wifi shield 2, firmware 1.5.0
log> sppc_begin: package 1.5.0
log> sppc_begin: WiFi AP phpoc_020447 ch2
log> sppc_begin: IPv4 192.168.0.1 255.255.0.0 0.0.0.0 192.168.0.1
log> phpoc_server : listen 2/80
WebSocket server address : 192.168.0.1
```

8. Run a web browser on your mobile or PC and connect to the web page of the shield.

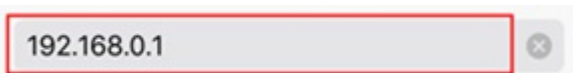

9. Click the [Web Remote Control / Pad].



Setup



Web Serial **Monitor**

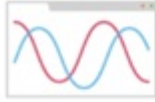

Web Serial **Plotter**

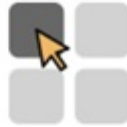

Web Remote **Push**

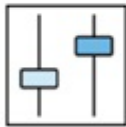

Web Remote **Slide**



Web Remote **Pad**

10. Click the [Connect] button.

Web Remote Pad

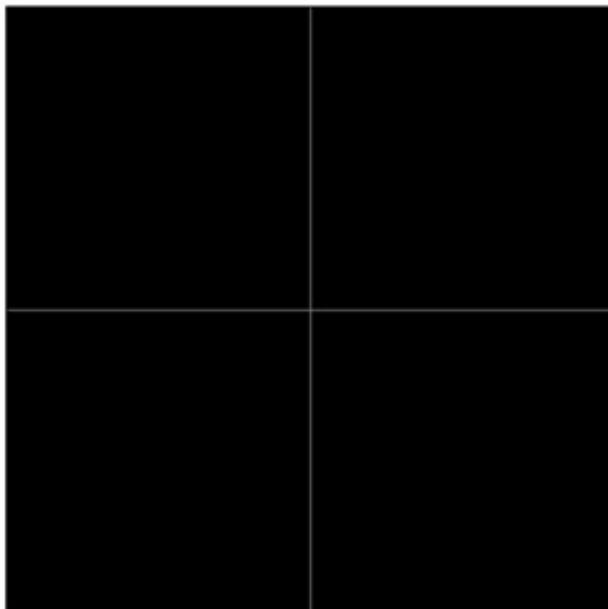

[HOME](#)

WebSocket CLOSED

[SETUP](#)

Coordinate: (0, 0)



Return to Center

11. Click or drag your mouse on the pad.

Web Remote Pad

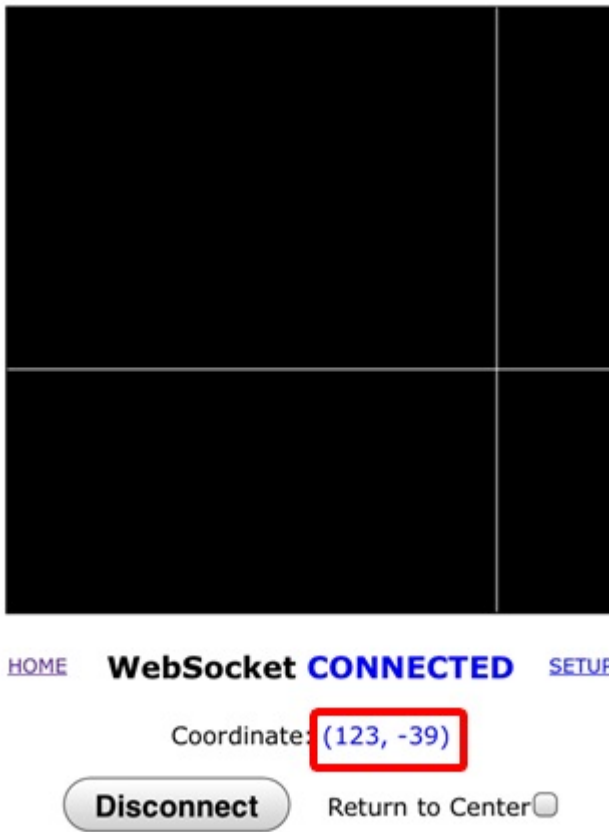

12. Check the messages on the serial monitor.

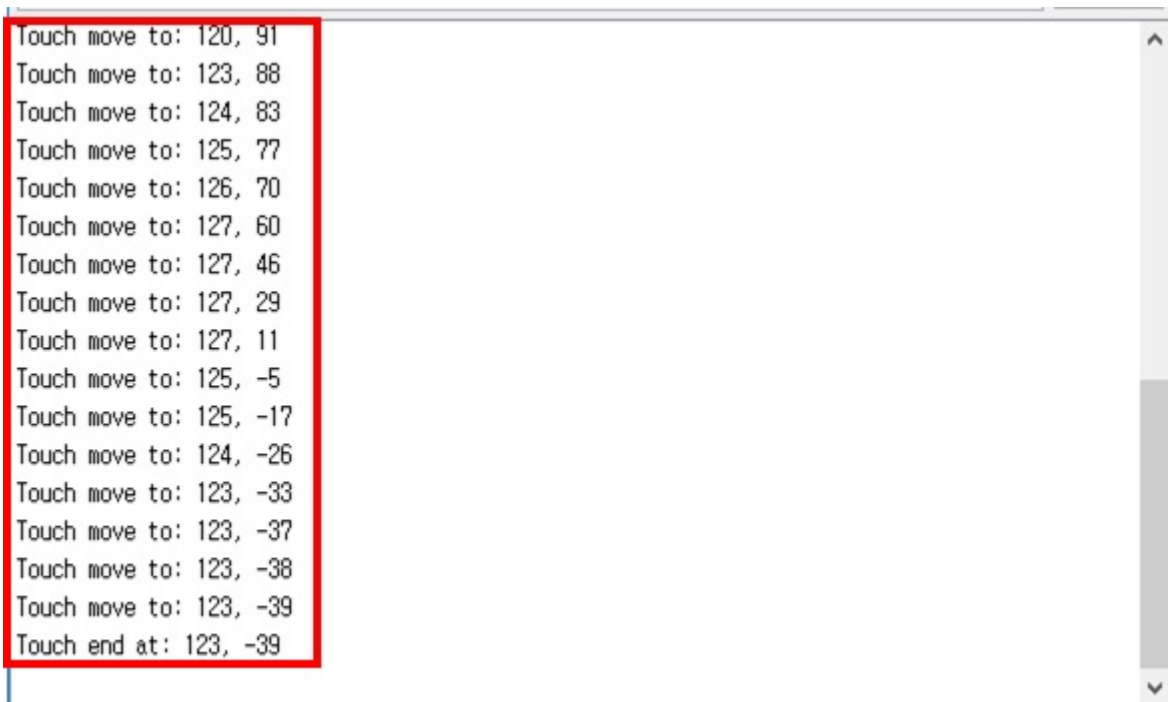

Setting the Time

This shield provides an RTC function for time information. With the built-in battery mounted on the shield, it maintains the time information even when the power is turned off.

Because of the built-in battery charging system, the battery is charged whenever the power is connected to the shield. However, if you do not connect power to shield for a long period (about 30 days in full-charged), the battery is discharged and time information may be initialized.

Setting the Time

1. Connect to the web setup page of shield.

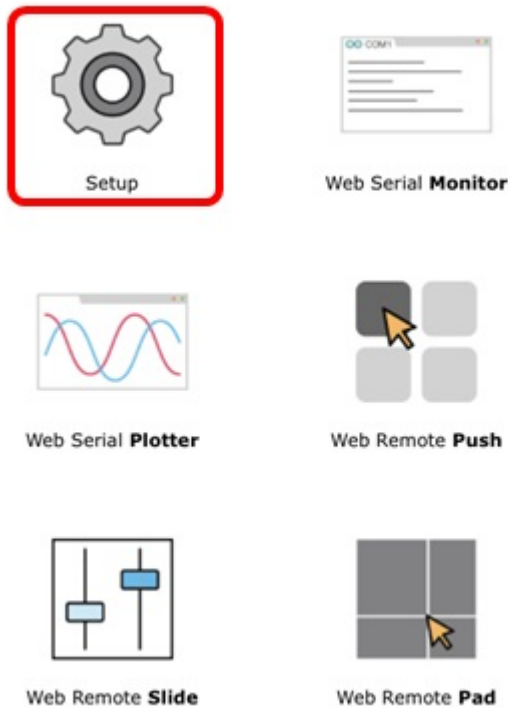

2. Move to the SETUP page.

The screenshot shows the 'SETUP' interface for a PHPoC device. The top navigation bar includes 'HOME', 'INFO' (selected), 'NETWORK', 'TIME', and 'APP'. The main content is divided into three sections: System Information, Network Information, and Wireless LAN Information.

System Information

Product name	PHPoC WiFi Shield 2
MAC address	00:30:f9:02:04:47
Firmware name	p4s_347_1.5.0.poc
Firmware version	1.5.0

Network Information

IPv4	IP address	192.168.0.1
	Subnet mask	255.255.0.0
	Gateway	0.0.0.0
	DNS Server	192.168.0.1
IPv6	Link Local	::0
	Global	::0 / 0
	Gateway	::0
	DNS Server	::0

Wireless LAN Information

3. Click the [TIME SYNC.] on the [TIME] tap.



PHPoC Shield Time	2018-11-16 10:11:15
Host local Time	2018-11-16 10:04:48

Note : Depending on the network environment, the synchronization may not match with host local time.

4. Check the [PHPoC Shield Time] is synchronized with the [Host Local Time].



PHPoC Shield Time	2018-11-16 10:05:07
Host local Time	2018-11-16 10:05:07

Note : Depending on the network environment, the synchronization may not match with host local time.



Settings for Web Applications

You can set parameters of web applications.

Setting parameters of web applications

1. Connect to the web setup page of shield.

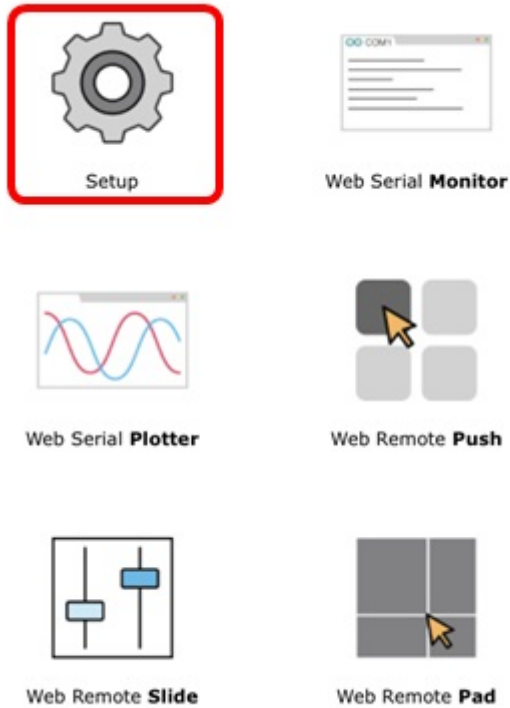

2. Move to the SETUP page.

The screenshot shows the 'SETUP' interface for a PHPoC device. At the top right, it says 'PHPoC'. Below the title, there are navigation tabs: 'HOME', 'INFO' (which is highlighted), 'NETWORK', 'TIME', and 'APP'. The main content is divided into three sections:

System Information

Product name	PHPoC WiFi Shield 2
MAC address	00:30:f9:02:04:47
Firmware name	p4s_347_1.5.0.poc
Firmware version	1.5.0

Network Information

IPv4	IP address	192.168.0.1
	Subnet mask	255.255.0.0
	Gateway	0.0.0.0
	DNS Server	192.168.0.1
IPv6	Link Local	::0
	Global	::0 / 0
	Gateway	::0
	DNS Server	::0

Wireless LAN Information

3. Click an application which you want to set on the [APP] tap.



Setting Parameters

Web Serial Monitor

parameter	description
Baud Rate	baud rate(9600 ~ 115200bps)
Width	width of the area(px)
Height	height of the area(px)

Web Serial Plotter

parameter	description
Baud Rate	baud rate(9600 ~ 115200bps)
Size Type	types of size(Fixed Size or Full Screen)
Width	width of the area(px)
Height	height of the area(px)
Max Sample	the number of maximum samples
Y-Axis Auto Scale	types of auto scale on Y-axis(Fixed or Auto Scale)
Y-Fixed Min Bound	maximum value of Y-axis
Y-Fixed Max Bound	minimum value of Y-axis
X-Axis Title	the title of X-axis

parameter	description
Y-Axis Title	the title of Y-axis

Web Remote Control(Push)

parameter	description
Width	width of the area(px)
Button	names of buttons, only appears if it has a name

Web Remote Control(Slide)

parameter	description
Width	width of the area(px)
Length	height of the area(px)
Max value	maximum value
Min value	minimum value

Web Remote Control(Pad)

parameter	description
Width	width of the area(px)
Height	height of the area(px)